

AIS 100 Splitter

Installation instructions



ENGLISH

Date: 01-2016

Document number: 87164-2

© 2016 Raymarine UK Limited

INNOVATION • QUALITY • TRUST

Raymarine[®]
BY  **FLIR**[®]

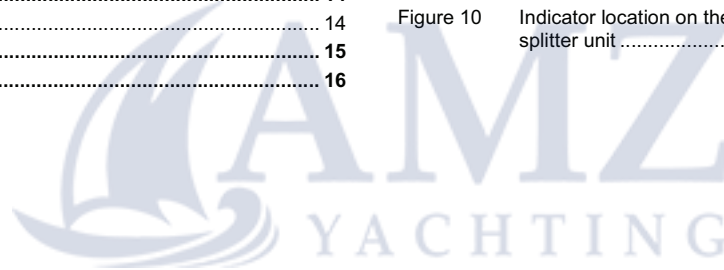

Table of contents

1	Notices	1
1.1	Safety warnings	1
1.2	General notices	1
2	About your AIS antenna splitter	3
2.1	About AIS	3
2.2	What's in the box?	4
3	Installation	6
3.1	Preparing for installation	6
3.2	Installation procedures	7
4	Operation	14
4.1	Status Indicator	14
5	Troubleshooting	15
6	Specifications	16

Table of figures

Figure 1	Items included with the product	4
Figure 2	AIS antenna splitter overview	5
Figure 3	Typical installation configuration	6
Figure 4	AIS antenna splitter dimensions	8
Figure 5	AIS antenna splitter mounting	9
Figure 6	Position of the VHF antenna connector	10
Figure 7	Position of the VHF radio connector	11
Figure 8	Position of the AIS transceiver connector	12
Figure 9	Connecting the power supply and optional FM output	13
Figure 10	Indicator location on the AIS antenna splitter unit	14



1 Notices



When reading this manual please pay particular attention to warnings marked with the warning triangle shown on the left. These are important messages for safety, installation and usage of the product.

1.1 Safety warnings



This equipment must be installed in accordance with the instructions provided in this manual.



Only use this AIS antenna splitter in conjunction with an approved AIS transceiver or receiver purchased from a reputable supplier.



Do not install this equipment in a flammable atmosphere such as in an engine room or near to fuel tanks.

1.2 General notices

Compass safe distance

The compass safe distance of this unit is 0.5m or greater for 0.3° deviation.

RF emissions notice

The information provided in this section assumes the AIS antenna splitter is connected to an AIS Class B transceiver.

The warnings regarding RF emissions provided in the manual for the VHF radio being used with the AIS antenna splitter should also be noted prior to installation of the AIS antenna splitter.

Caution: The AIS antenna splitter generates and radiates radio frequency electromagnetic energy. This equipment must be installed and operated according to the instructions contained in this manual. Failure to do so can result in personal injury and/or the malfunction of the AIS antenna splitter and/or the AIS transceiver it is connected to.

Caution: Never operate the AIS antenna splitter unless it is connected to a VHF antenna.

To maximise performance and minimise human exposure to radio frequency electromagnetic energy you must make sure that the antenna is mounted at least 1.5 meters away from the AIS antenna splitter and is connected to the AIS antenna splitter before power is applied.

The system has a Maximum Permissible Exposure (MPE) radius of 1.5m. This has been determined assuming the maximum power of the AIS transceiver and using antennas with a maximum gain of 3dBi.

The antenna should be mounted 3.5m above the deck in order to meet RF exposure requirements. Higher gain antennas will require a greater MPE radius. Do not operate the unit when anyone is within the MPE radius of the antenna (unless they are shielded from the antenna field by a grounded metallic barrier). The antenna should not be co-located or operated in conjunction with any other transmitting antenna. The required antenna impedance is 50 ohms.

Warranty

This product is supplied with standard warranty as defined in the accompanying warranty information.



Any attempt to tamper with or damage the product will invalidate the warranty.

Disposal of this product and packaging

Please dispose of this AIS antenna splitter in accordance with the European WEEE Directive or with the applicable local regulations for disposal of electrical equipment.

Every effort has been made to ensure the packaging for this product is recyclable. Please dispose of the packaging in an environmentally friendly manner.

Accuracy of this manual

The AIS antenna splitter may be upgraded from time to time and future versions of the AIS antenna splitter may therefore not correspond exactly with this manual. The manufacturer of this product disclaims any liability for consequences arising from omissions or inaccuracies in this manual and any other documentation provided with this product.

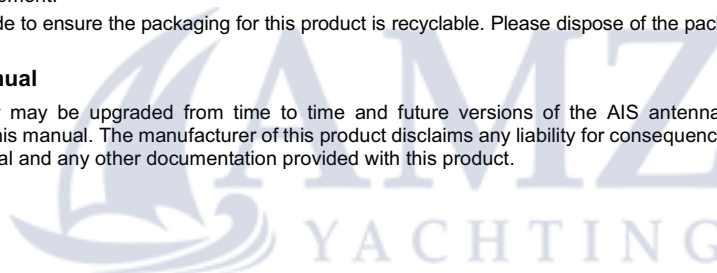

2 About your AIS antenna splitter

2.1 About AIS

The marine Automatic Identification System (AIS) is a location and vessel information reporting system. It allows vessels equipped with AIS to automatically and dynamically share and regularly update their position, speed, course and other information such as vessel identity with similarly equipped vessels. Position is derived from the Global Positioning System (GPS) and communication between vessels is by Very High Frequency (VHF) digital transmissions.

There are a number of types of AIS device as follows:

- **Class A transceivers.** These are similar to class B transceivers but are designed to be fitted to large vessels such as cargo ships and large passenger vessels. Class A transceivers transmit at a higher VHF signal power than class B transceivers and therefore can be received by more distant vessels, and also transmit more frequently. Class A transceivers are mandatory on all vessels over 300 gross tonnes on international voyages and certain types of passenger vessels under the SOLAS mandate.
- **Class B transceivers.** Similar to class A transceivers in many ways, but are normally lower cost due to the less stringent performance requirements. Class B transceivers transmit at a lower power and at a lower reporting rate than class A transceivers.
- **AIS base stations.** AIS base stations are used by Vessel Traffic Systems to monitor and control the transmissions of AIS transceivers.
- **Aids to Navigation (AtoN) transceivers.** AtoNs are transceivers mounted on buoys or other hazards to shipping which transmit details of their location to the surrounding vessels.
- **AIS receivers.** AIS receivers will generally receive transmissions from class A transceivers, class B transceivers, AtoNs and AIS base stations but do not transmit any information about the vessel on which they are installed.

Because VHF radios and AIS devices operate within the same frequency range and therefore require the same type of VHF antenna it is possible to utilise a single VHF antenna for both devices by using an AIS antenna splitter.

This AIS antenna splitter is designed to work primarily with AIS class B transceivers, although it will operate equally well with AIS receivers.



It is not recommended to use this AIS antenna splitter with Class A transceivers, Aids to Navigation transceivers or AIS base stations.

2.2 What's in the box?

Figure 1 shows the items included with your AIS antenna splitter purchase. The following sections give a brief overview of each item. Please ensure all items are present and if any of the items are not present contact your dealer.

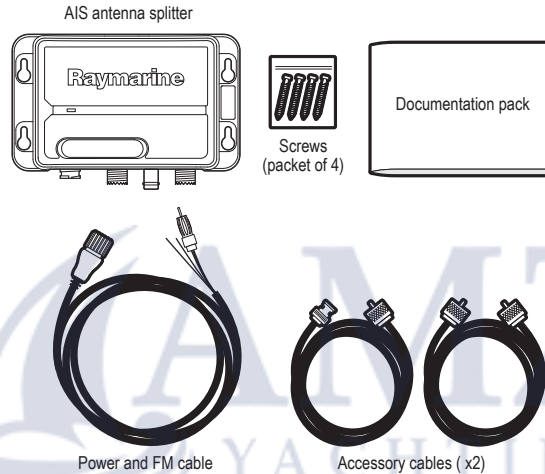

Figure 1 Items included with the product

- **Documentation pack**

The documentation pack contains the product installation instructions and warranty policy, the installation instructions should be read thoroughly prior to any attempt to install or use the AIS antenna splitter.

- **VHF radio connection cable**

This cable is used to connect a VHF radio to the AIS antenna splitter. The cable has PL259 connectors at either end and requires a SO239 connector on the VHF radio. If your VHF radio does not have a SO239 connector please contact your dealer for details of suitable adaptors.

- **AIS transceiver connection cable**

This cable is used to connect an AIS transceiver to the AIS antenna splitter. The cable has a BNC connector at one end (for connection to the AIS antenna splitter) and a PL259 connection at the opposite end (for connection to an AIS transceiver with an SO239 VHF connector). If your AIS transceiver does not use an SO239 connector please contact your dealer for details of suitable adaptors.

- **AIS antenna splitter unit**

Figure 2 shows an overview of the AIS antenna splitter unit.

The AIS antenna splitter has a number of indicators which provide information to the user about the status of the AIS antenna splitter. Please refer to section 4 for more details of the indicator functions.

The AIS antenna splitter mounting holes are located as shown in Figure 2. Please refer to section 3.2 for details of how to mount the AIS antenna splitter.

- **Power and FM cable**

The power and FM cable connects to the AIS antenna splitter and enables connection to power and an FM radio antenna input.

Electrical connections

The AIS antenna splitter has the following electrical connections as shown in Figure 2.

- Power supply
- VHF antenna connector
- VHF radio connector
- AIS transceiver connector
- FM radio connector

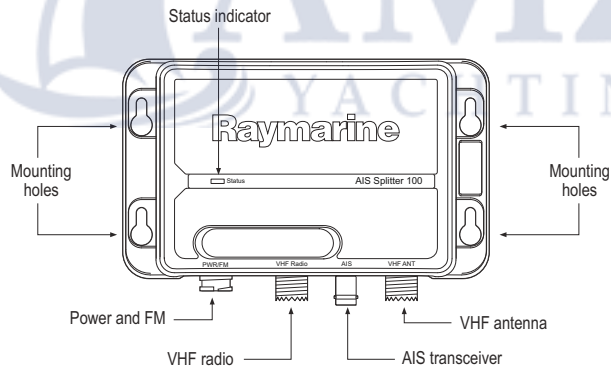

Figure 2 AIS antenna splitter overview

3 Installation

3.1 Preparing for installation

Figure 3 shows a typical installation configuration for the AIS antenna splitter. Please take the time to familiarise yourself with the system elements and their connections prior to attempting installation.

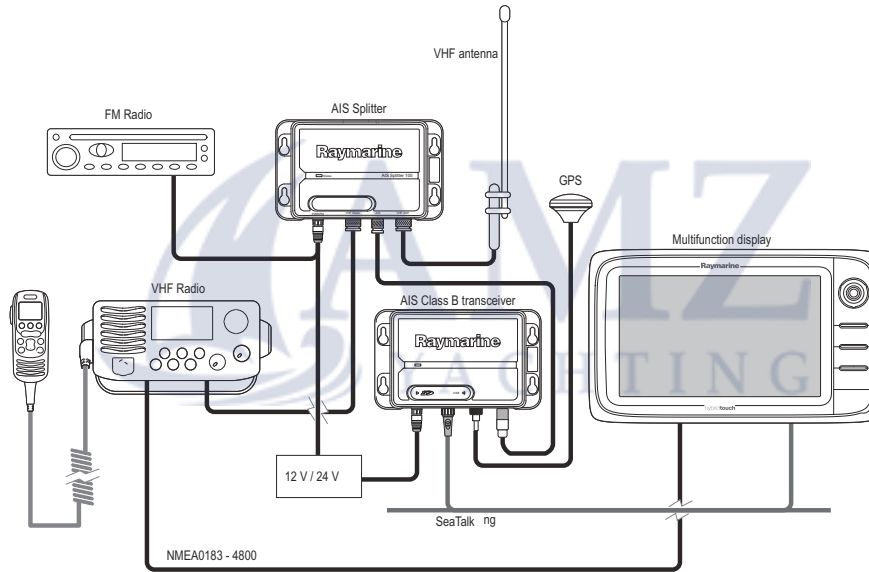

Figure 3 Typical installation configuration

In addition to the items provided with your AIS antenna splitter the following items will be required for installation:

VHF antenna

Connection to a suitable VHF antenna will be required for the AIS antenna splitter to operate. A standard marine band VHF antenna such as that used with VHF voice radios will be sufficient. Please take note of the warnings in section 1 regarding the use of antennas.

VHF radio

If you have an existing VHF voice radio connected directly to a VHF antenna, you can disconnect the VHF radio from the VHF antenna and connect them both to the relevant connectors on the AIS antenna splitter.

AIS transceiver

If you have an existing AIS transceiver connected directly to a VHF antenna, you can disconnect the AIS transceiver from the VHF antenna and connect them both to the relevant connectors on the AIS antenna splitter.

It is necessary to connect the VHF antenna, VHF radio and AIS transceiver for the antenna splitter to function correctly.

FM radio

The AIS antenna splitter also provides connections for the antenna of an FM broadcast radio receiver. Connection of an FM radio is optional.

Power cable

The AIS antenna splitter is supplied with a two meter long power cable. If you require longer cables to reach your power supply please ensure the cables are capable of carrying currents of up to 200mA on average. Means of connecting the cables together will also be required. The use of Scotchlok™ connectors is recommended for this purpose.

3.2 Installation procedures

Before beginning installation of your AIS antenna splitter, please ensure you have the necessary additional items as detailed in section 3.1. It is strongly recommended that you read all of the instructions in this manual prior to installation.

If after reading this manual you are unsure about any element of the installation process please contact your dealer for advice.

The following sections explain the installation process step by step for each of the main elements of the system.

Step 1 - Installing the AIS antenna splitter

Please note the following guidelines when selecting a location for your AIS antenna splitter:

- The AIS antenna splitter must be fitted in a location where it is at least 0.5m from a compass or any magnetic device.
- There should be adequate space around the AIS antenna splitter for routing of cables. See Figure 4 for details of the AIS antenna splitter dimensions.
- The ambient temperature around the AIS antenna splitter should be maintained between -25°C and +55°C.
- The AIS antenna splitter should not be located in a flammable or hazardous atmosphere such as in an engine room or near to fuel tanks.
- The AIS antenna splitter is waterproof to ingress protection rating IPx2 and should be installed in a 'below decks' environment.

- It is acceptable to mount the AIS antenna splitter either vertically or horizontally.
- The AIS antenna splitter should be mounted in a location where the status indicator is readily visible as these provide important information on the status of the AIS antenna splitter.

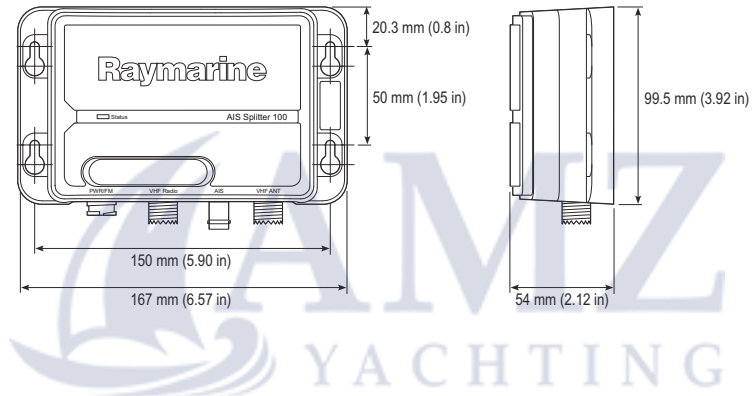

Figure 4 AIS antenna splitter dimensions

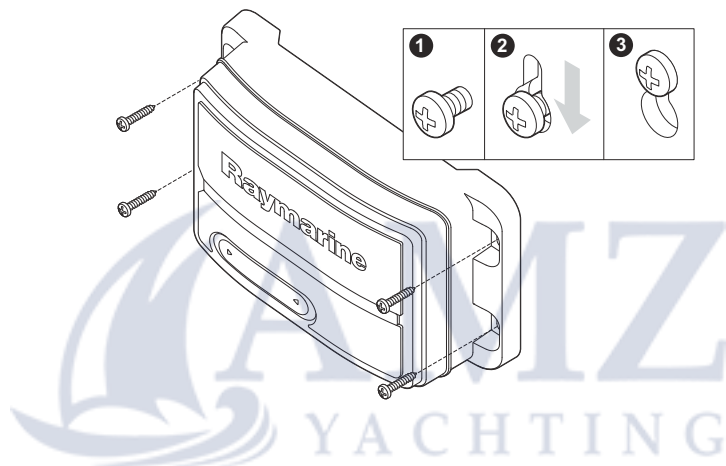

Figure 5 AIS antenna splitter mounting

Step 2 - Connecting the VHF antenna

Route the cable from the VHF antenna to the AIS antenna splitter and connect to the VHF antenna connector on the AIS antenna splitter as shown in Figure 6.

A standard marine band VHF antenna or AIS antenna should be used with the AIS antenna splitter. The connector type on the AIS antenna splitter is SO239. Your chosen VHF antenna requires a PL259 connector to mate with this. If your VHF antenna does not use this type of connector please contact your dealer for details of available adaptors.

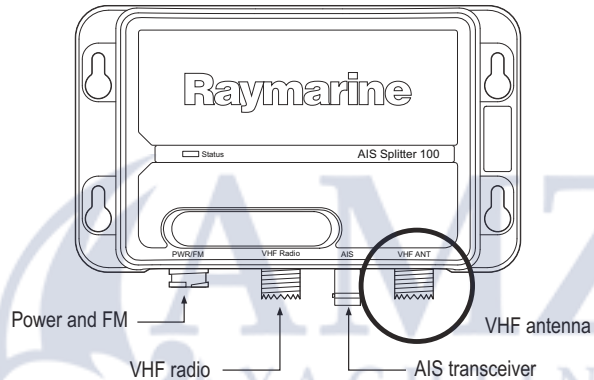

Figure 6 Position of the VHF antenna connector

Step 3 - Connecting the VHF radio

Using the VHF radio accessory cable provided with this product, route the cable from the VHF radio to the AIS antenna splitter and connect to the VHF radio connector on the AIS antenna splitter as shown in Figure 7. If the cable supplied is not long enough please contact your dealer for details of suitable extension cables.

A standard marine band VHF voice radio should be used with this AIS antenna splitter. The antenna splitter is DSC compatible.

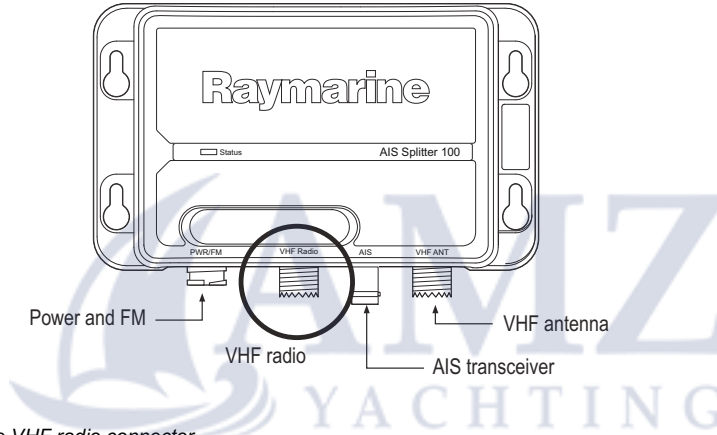

Figure 7 Position of the VHF radio connector

Step 4 - Connecting the AIS transceiver

Using the AIS transceiver accessory cable provided with this product, route the cable from the AIS transceiver to the AIS antenna splitter and connect to the AIS transceiver connector on the AIS antenna splitter as shown in Figure 8. If the cable supplied is not long enough please contact your dealer for details of suitable extension cables.

A fully approved marine AIS class B transceiver or AIS receiver should be used with this AIS antenna splitter and requires a SO239 VHF antenna connector to connect to the AIS antenna splitter using the supplied accessory cable.

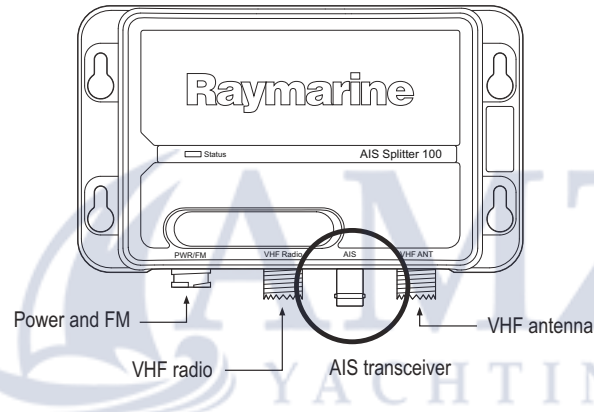

Figure 8 Position of the AIS transceiver connector

Step 5 - Connecting the power supply and optional FM output

The AIS antenna splitter requires a 12V or 24V power supply typically provided by the vessel's battery. It is recommended that crimped and soldered lugs are used to connect the AIS antenna splitter to the power source. It is recommended that the power supply is connected via a suitable circuit breaker and/or 1A fuse block.

1. Connect the red wire to the power supply positive terminal.
2. Connect the black wire to the supply negative terminal.
3. Connect the output jack to the FM antenna input of an (optional) FM radio.

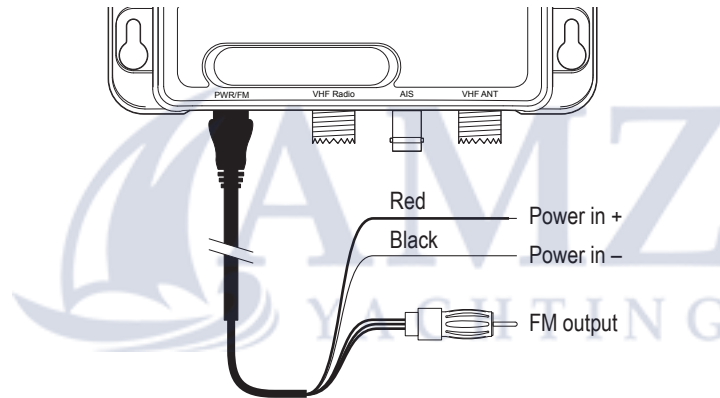

Figure 9 Connecting the power supply and optional FM output

4 Operation

Operation of the AIS antenna splitter is automatic and requires no user intervention.

During operation the antenna splitter will share signals received at your VHF antenna with both the AIS transceiver and the VHF radio.

When either the AIS transceiver or VHF radio transmits, the AIS antenna splitter will automatically sense the transmission and route the signal to the antenna.

In the event that both the VHF radio and AIS transceiver are transmitting at the same time, the AIS antenna splitter will give priority to the VHF radio.



It is not possible for both connected devices to transmit simultaneously using a single VHF antenna. Whilst you are talking on your VHF radio no AIS position reports will be transmitted.

4.1 Status Indicator

The AIS antenna splitter includes an status indicator LED as shown in Figure 10. The state of the indicator provides information regarding the status of the AIS antenna splitter.

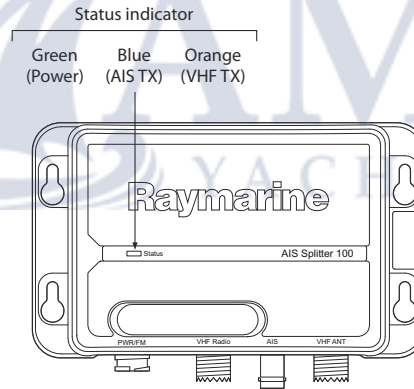

Figure 10 Indicator location on the AIS antenna splitter unit

The LED provides the following indications:

- Power - the indicator is illuminated Green whilst the unit is powered
- TX AIS - the indicator flashes Blue to indicate AIS transmissions
- TX VHF - the indicator flashes Orange to indicate VHF radio transmissions

5 Troubleshooting

Issue	Possible cause and remedy
Power indicator not illuminated	Check power supply connections and fuse or circuit breaker Check polarity of power supply connections Check power supply voltage
'VHF' indicator does not illuminate when VHF Radiotelephone is transmitting	Check the antenna output of the VHF Radiotelephone is connected to the antenna splitter input labelled 'VHF ANT'
'AIS' indicator does not illuminate when AIS transceiver is transmitting	Check the antenna output of the AIS transceiver is connected to the antenna splitter input labelled 'AIS'
Clicks or pops are heard from a connected FM broadcast receiver	This is normal and may occur during VHF or AIS transmission
VHF or AIS transmission range is reduced	A small reduction in transmission range is normal and due to the insertion loss of the antenna splitter

If the guidance given in the table above does not rectify the problem you are experiencing please contact your dealer for further assistance.

6 Specifications

Parameter	Value
Dimensions	167 x 54 x 99.5 mm (L x W x H)
Weight	250g
Voltage supply	DC 9.6 to 31.2V
Current consumption	<150mA at 12VDC
VHF and AIS frequency range	156MHz to 163MHz
Insertion loss AIS & VHF receive paths 0dB	0dB
Insertion loss AIS & VHF transmit paths	<1dB
Max input power, AIS port	12.5W
Max input power, VHF port	25W
Min input power, VHF port	100mW
AIS, VHF and Antenna port impedence	50 Ohms
FM port impedence	75 Ohms
Switching time, receive to AIS transmit	<10us
Switching time, receive to VHF transmit	<10us
Operating temperature:	-10°C to +55°C
Ingress protection	IPx2

Owner notes:



Owner notes:



Owner notes:







www.raymarine.com

